

Article number: 0106072

Description: Retaining ring JV 55

## Measures

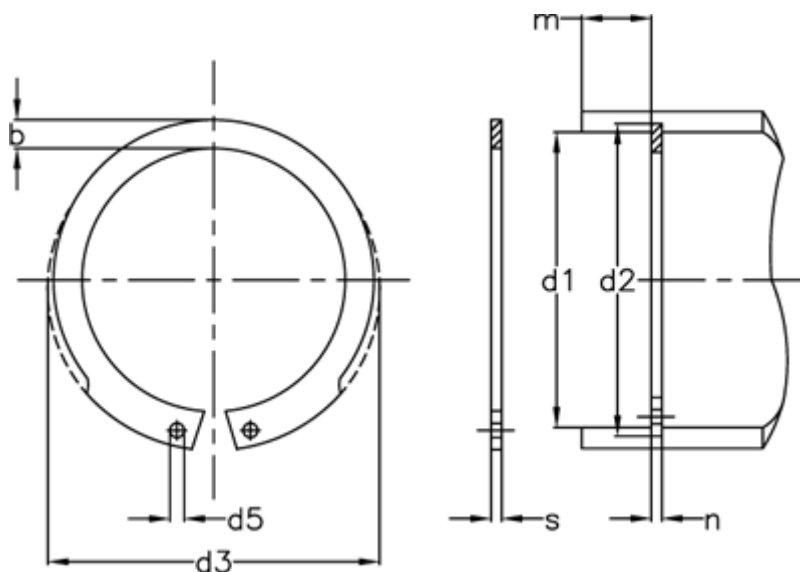

AN mm <sup>2</sup>	= 133	FRg kN	= 13.3	tol	= 0.2
b	= 5.2	FR kN	= 66.0	tol	= -0.07
d1	= 55	g	= 2.0	tol	= +1,10-0,46
d2	= 58.0	K kN-mm	= 118.0	tol	= +0,30
d3	= 59.2	m min	= 2.15	Tong	= ZGJ-3
d5 min	= 2.5	Nominal drive	= 4.5	Weight kg/1000	= 10.00
Description	= JV 55	s	= 2.00		
FN kN	= 22.20	t	= 1.50		